



# COMBUSTION

By: **Michael Biarnes**

In collaboration with:  
**Bill Freed and Jason Esteves**

**E Instruments International LLC - [www.E-Inst.com](http://www.E-Inst.com)**

# Combustion

## What is Combustion?

Combustion takes place when fuel, most commonly a fossil fuel, reacts with the oxygen in air to produce heat. The heat created by the burning of a fossil fuel is used in the operation of equipment such as boilers, furnaces, kilns, and engines. Along with heat, CO<sub>2</sub> (carbon dioxide) and H<sub>2</sub>O (water) are created as byproducts of the exothermic reaction.



By monitoring and regulating some of the gases in the stack or exhaust, it is easy to improve combustion efficiency, which conserves fuel and lowers expenses. Combustion efficiency is the calculation of how effectively the combustion process runs. To achieve the highest levels of combustion efficiency, complete combustion should take place. Complete combustion occurs when all of the energy in the fuel being burned is extracted and none of the Carbon and Hydrogen compounds are left unburned. Complete combustion will occur when the proper amounts of fuel and air (fuel/air ratio) are mixed for the correct amount of time under the appropriate conditions of turbulence and temperature.

Although theoretically stoichiometric combustion provides the perfect fuel to air ratio, which thus lowers losses and extracts all of the energy from the fuel; in reality, stoichiometric combustion is unattainable due to many varying factors. Heat losses are inevitable thus making 100% efficiency impossible.



In practice, in order to achieve complete combustion, it is necessary to increase the amounts of air to the combustion process to ensure the burning of all of the fuel. The amount of air that must be added to make certain all energy is retrieved is known as excess air.

In most combustion processes, some additional chemicals are formed during the combustion reactions. Some of the products created such as CO (carbon monoxide), NO (nitric oxide), NO<sub>2</sub> (nitrogen dioxide), SO<sub>2</sub> (sulfur dioxide), soot, and ash should be minimized and accurately measured. The EPA has set specific standards and regulations for emissions of some of these products, as they are harmful to the environment.

Combustion analysis is a vital step to properly operate and control any combustion process in order to obtain the highest combustion efficiency with the lowest emissions of pollutants.

## Objective of Combustion

The objective of combustion is to retrieve energy from the burning of fuels in the most efficient way possible. To maximize combustion efficiency, it is necessary to burn all fuel material with the least amount of losses. The more efficiently fuels are burned and energy is gathered, the cheaper the combustion process becomes.

**Complete Combustion** – Complete combustion occurs when 100% of the energy in the fuel is extracted. It is important to strive for complete combustion to preserve fuel and improve the cost efficiency of the combustion process. There must be enough air in the combustion chamber for complete combustion to occur. The addition of excess air greatly lowers the formation of CO (carbon monoxide) by allowing CO to react with O<sub>2</sub>. The less CO remaining in the flue gas, the closer to complete combustion the reaction becomes. This is because the toxic gas carbon monoxide (CO) still contains a very significant amount of energy that should be completely burned.

**Stoichiometric Combustion** – Stoichiometric combustion is the theoretical point at which the fuel to air ratio is ideal so that there is complete combustion with perfect efficiency. Although stoichiometric combustion is not possible, it is striven for in all combustion processes to maximize profits.



Oil Flame



Gas Flame

**Fuel - Air Ratio** – The fuel-air ratio is the proportion of fuel to air during combustion. The optimal ratio (the stoichiometric ratio) occurs when all of the fuel and all of the oxygen in the reaction chamber balance each other out perfectly. Rich burning is when there is more fuel than air in the combustion chamber while lean burning occurs when there is more air than fuel in the combustion chamber.

**Fuels** – There are many fuels currently used in combustion processes throughout the world, the most common are: Coal, Oils (#2, # 4, and # 6), Diesel Oil, Gasoline, Natural Gas, Propane, Coke Oven Gas, and Wood. Each fuel has different chemical characteristics including, a unique C/H<sub>2</sub> ratio, and calorific value, among others. The amount of combustion air required to completely burn a specific fuel will depend on those characteristics especially the C/H<sub>2</sub> ratio. The higher the carbon in the fuel the more air is required to achieve complete combustion. When monitoring the efficiency of a combustion process, it is important to know the fuel being burned since this information will help not only determine a boiler's optimal working conditions but also maximize the boiler's efficiency.

## Effect of burning different fuels

- **Coal** – There are many varieties of coal being used in combustion processes around the world; the most widely used are anthracite, bituminous, sub-bituminous, and lignite. When burning coal a considerable amount of carbon dioxide is generated given the extremely high levels of carbon in coal; since carbon requires more oxygen to burn, more combustion air is needed to burn coal than other fossil fuels.

In addition to the carbon dioxide emissions, coal burning creates some other pollutants including NO<sub>x</sub>, sulfur dioxide (SO<sub>2</sub>), sulfur trioxide (SO<sub>3</sub>), and particle emissions. Sulfur dioxide chemically combines with water vapor in the air to produce a weak form of sulfuric acid, one of the main causes of acid rain.

- **Oil** – Oil fuels are mostly a mixture of very heavy hydrocarbons, which have higher levels of hydrogen than those found in coal. At the same time, oil contains less carbon than coal and therefore requires less combustion air to achieve complete combustion. Therefore, burning oil releases less carbon dioxide than burning coal, but more carbon dioxide than burning natural gas. Most of the pollutants produced when burning coal are also a byproduct of burning oil.

- **Natural Gas** – Natural gas requires much less air in combustion because of its relatively low amounts of carbon and high amounts of hydrogen. The burning of natural gas is cleaner than the burning of oil and coal. When gas is burned with insufficient combustion air some volatile hydrocarbons can be created, which could become a safety hazard; care should be taken to avoid dangerous conditions.

The burning of natural gas produces less greenhouse gases, which are believed to be one of the main sources for global warming. In equivalent amounts, burning natural gas produces about 30% less carbon dioxide than burning oil and 45% less carbon dioxide than burning coal.

In addition to the carbon dioxide emissions, gas burning creates NO<sub>x</sub> emissions, while the emissions of sulfur dioxide (SO<sub>2</sub>) and Particles are negligible.

- **Other Fuels** – Other fuels including wood, diesel, gasoline, propane, butane, bio fuels such as ethanol, etc. have their own combustion properties that will affect the combustion efficiency and emissions of the process.



**Biomass Dust Burner**

## Air Flow

Maintain appropriate airflow during combustion is fundamental to ensure safe and complete combustion. The total airflow includes combustion air, infiltration air, and dilution air.

- **Combustion Air** – Combustion air is the air that is used to actually burn the fuel. Without combustion air, which is normally forced into the furnace, combustion is impossible.
- **Infiltration Air** – Infiltration air is the outdoor air that is not deliberately in the boiler. Sources of infiltration air maybe cracks or leaks.
- **Dilution Air** – Dilution air is the air that combines with the flue gases and lowers the concentration of the emissions. There are two types of dilution air, natural and induced (artificially created).

## Time, Temperature and Turbulence

The combustion process is extremely dependent on time, temperature, and turbulence. Time is important to combustion because if a fuel is not given a sufficient amount of time to burn, a significant amount of energy will be left in the fuel. Too much time to burn on the other hand will produce very long flames, which can be a function of bad mixing. The correct balance of time and mixing will achieve complete combustion, minimize flame impingement (boiler maintenance hazard), and improve combustion safety. In addition, a properly controlled combustion process strives to provide the highest combustion efficiency while maintaining low emissions of harmful gases.

**Excess Air** – In order to ensure complete combustion, combustion chambers are fired with excess air. Excess air increases the amount of oxygen and nitrogen entering the flame increasing the probability that oxygen will find and react with the fuel. The addition of excess air also increases turbulence, which increases mixing in the combustion chamber. Increased mixing of the air and fuel will further improve combustion efficiency by giving these components a better chance to react. As more excess air enters the combustion chamber, more of the fuel is burned until it finally reaches complete combustion. Greater amounts of excess air create lower amounts of CO but also cause more heat losses. Because the levels of both CO and heat losses affect the combustion efficiency, it is important to control and monitor excess air and the CO levels to ensure the highest combustion efficiency possible.

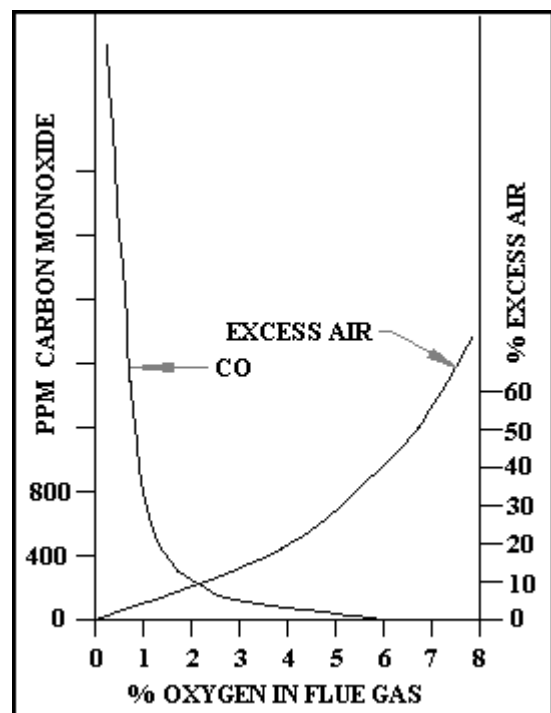

## - Calculating Excess Air

As discussed earlier, under stoichiometric (theoretical) conditions, the amount of oxygen in the air used for combustion is completely depleted in the combustion process. Therefore, by measuring the amount of oxygen in the exhaust gases leaving the stack we should be able to calculate the percentage of excess air being supplied to the process.

The following formula is normally used to calculate the excess air:

$$\% \text{ Excess Air} = \frac{\% \text{O}_2 \text{ measured}}{20.9 - \% \text{O}_2 \text{ measured}} \times 100$$

## Typical Excess Air Values

Fuel	Type of Furnace	Excess Air %
Pulverized Coal	Partially Water Cooled Furnace	15-40%
Coal	Spreader stoker	30-60%
Coal	Underfeed Stoker	20-50%
Fuel Oil	Oil Burners, register type	5-10%
Fuel Oil	Multifuel burners & flat-flame	10-20%
Natural Gas	Register type Burners	5-10%

## What is Draft?

The pressure of the gases in the stack must be carefully controlled to insure that all the gases of combustion are removed from the combustion zone at the correct rate. This draft pressure can be positive or negative depending of the boiler design; natural draft, balance draft, and forced draft boilers are the most commonly used in the industry.

Monitoring draft is important not only to increase combustion efficiency, but also to maintain safe conditions. Low draft pressures create build-ups of highly toxic gases such as carbon monoxide and highly explosive gases. These build ups may take place in the combustion chamber or may even be ventilated indoors creating the risk of injury and death. Conversely, extremely high draft pressures can cause unwanted turbulences in the system preventing complete combustion. Unwanted high draft pressures tend to damage the combustion chamber and heat exchanger material by causing flame impingement.

## What is a Boiler?

A boiler is an enclosed vessel in which water is heated and circulated, either as hot water, steam, or superheated steam for the purpose of heating, powering, and/or producing electricity. The furnace of the boiler is where the fuel and air are introduced to combust; fuel/air mixtures are normally introduced into the furnace by using burners, where the flames are formed. The resulting hot gases travel through a series of heat exchangers, where heat is transferred to the water flowing through them. The combustion gases are finally released to the atmosphere via the stack of exhaust section of the boiler.

## Different Boiler Types

- Utility Boilers

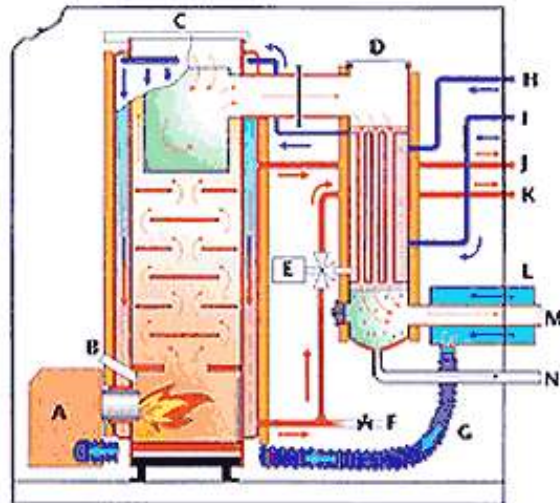

- Industrial Boilers

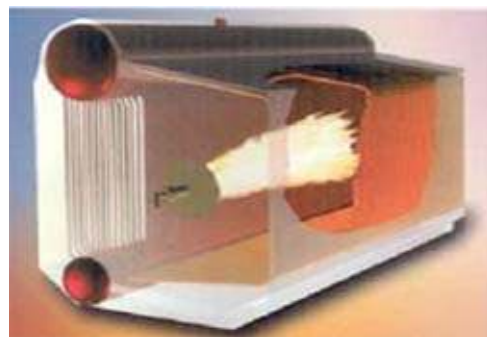



- **Commercial Boilers**

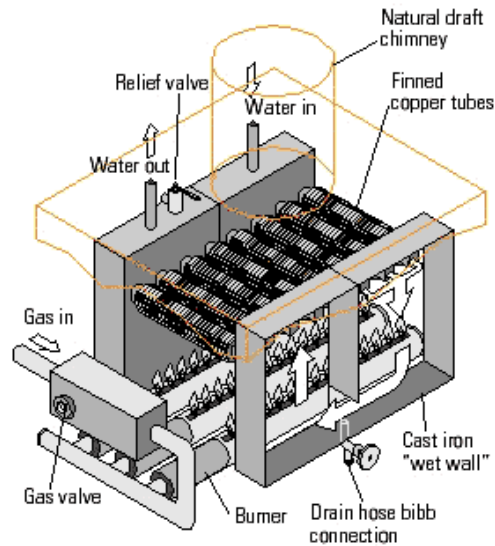
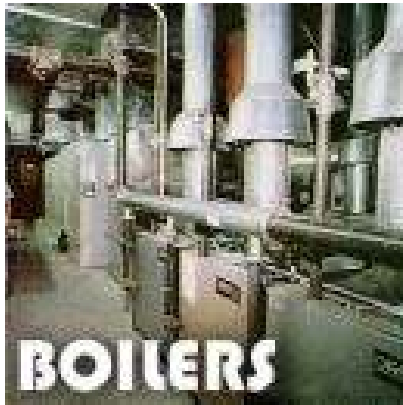

- **Condensing Boilers**

A condensing boiler preserves energy by using heat exchangers designed to remove additional energy from the gases of combustion before leaving the stack. The flue gases produced from condensing boilers are at a much lower temperatures than those of non condensing boilers to the extent that the water vapor in the flue gases condenses, thus releasing their latent heat and increasing efficiency of the boiler. Condensing boilers have efficiencies of 95% or greater as compared to the normal 70%-80% for non-condensing boilers.

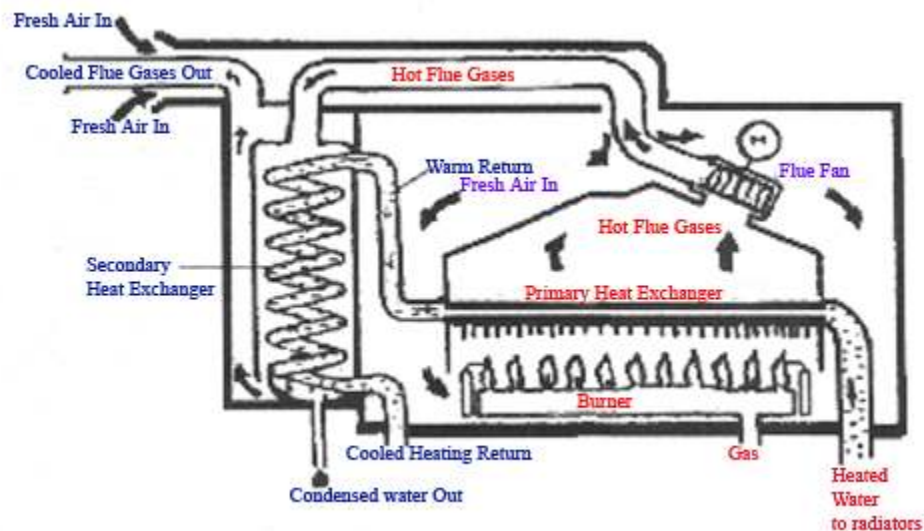



# Total Efficiency Concept

Total Efficiency Concept is an innovative method to maximize the overall performance of a combustion process by measuring and controlling the different parameters corresponding to the four most important areas of process operation, which are Combustion Efficiency, Maintenance Efficiency, Safety, and Environmental Efficiency. By balancing all of the requirements set forth in each of these areas, it is possible to operate under conditions that allow for the most cost efficient and safe working environment, while still complying with the environmental regulations applicable to the combustion process.

- **Combustion Efficiency** – It is important to strive for perfect combustion efficiency, but many times perfect combustion efficiency is impractical due to the requirements of maintenance efficiency, safety, environmental efficiency, and fuel efficiency.

- **Maintenance Efficiency** – Although a brand new burner or boiler may run extremely efficiently with little or no problems, as time goes on, the same boiler slowly begins to lower its efficiency. This is because as a boiler or burner gets older it becomes dirtier and deteriorates. This affects the combustion process greatly and can seriously affect emissions and safety. In most cases, as a burner wears down, more excess air will be needed to ensure proper combustion and reduce CO emissions. To ensure that efficiency is maintained when a boiler ages, it is important to closely monitor the amount of O<sub>2</sub> needed to produce proper combustion and CO emissions.

- **Safety** – Safety is a major concern when dealing with any form of combustion. The toxic emissions that are released along with the risk of possible explosions can cause great harm. Older parts that are used in the combustion process can create more dangerous conditions. To ensure complete safety it is essential to monitor levels of CO and C<sub>x</sub>H<sub>y</sub> (hydrocarbons). It is also necessary to check the amounts of oxygen needed to ensure low levels of CO and hydrocarbons. CO is a toxic gas that can be lethal in higher concentrations. Hydrocarbons contain unburned fuel, which can cause explosions and consequently, great injury.

- **Environmental Efficiency** – Toxic compounds such as sulfur dioxide, carbon monoxide, nitrogen oxides, and particles are undesirable emissions that are frequently results of the combustion of fossil fuels. These compounds cause smog, acid rain, and respiratory problems. In effort to reduce these pollutants federal and state laws have been established under the guidelines of the Clean Air Act and the EPA (Environmental Protection Agency). Combustion analysis aids in monitoring these toxic gases and meeting the regulations set forth by the government and EPA.



# Combustion Efficiency

## Heat Losses

It is vital to keep heat losses to a minimum so that efficiency is maximized and more energy is conserved. Heat losses are inevitable, especially through the stack, but great amounts of heat losses may be prevented with the proper measurement and control procedures.

*Total heat losses* are normally tallied by adding the *stack losses*, the *skin/shell losses*, and the *losses due to the un-burned fuel in ash* collection hoppers.

*Stack losses* will combine the *sensible heat losses or dry gas losses* and the *latent heat losses*. Sensible heat losses relate to the heat used to heat the combustion gases exiting the stack; the higher the volume and temperature of the flue gases the larger the dry gas heat losses. Latent heat losses are due to the water vapor in the flue gases (a large amount of energy is used as water evaporates).

Skin/shell losses, which are the losses due to radiation from the boiler walls can be minimized with proper insulation and in general are relatively small.

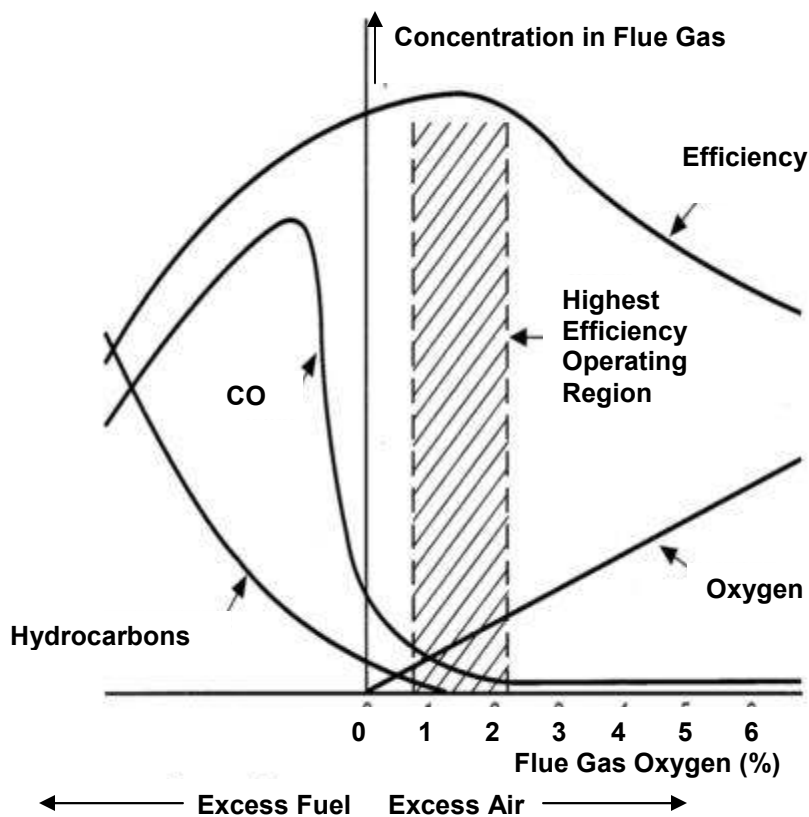

In coal and wood fired boilers, ash is normally a by-product of combustion that is collected in hoppers or ash collection areas; it is imperative that the amount of carbon left in those ashes is reduced to extremely small amounts given the resulting heat losses and the negative effects that carbon has in disposing of those ashes.

## Measuring Combustion Efficiency

Although combustion efficiency can not be measured directly, it can be calculated by identifying all of the losses that occur during combustion. It is important to consider all factors including sensible heat losses, unburned gases, radiation, and unburned particles. In most instances, the values of the skin losses and latent heat losses are not taken into account. The following equation can be used to calculate combustion efficiency:

$$\% \text{Efficiency} = 100\% - \frac{\text{Total Heat losses}}{\text{Fuel heating value}} \times 100$$

## Typical combustion process efficiencies:

**Home fireplace:** 10 - 40 %

**Space heater:** 50 - 80 %

**Residential gas furnace with low efficiency atmospheric burner:** 70 - 80 %

**Oil burner heating system:** 70 - 85 %

**Gas powered boiler:** 75 - 85 %

**High efficiency gas or oil condensing furnace:** 85 - 95 %

# Emissions

## Nitrogen Oxides: What is NO<sub>x</sub>?

Nitrogen Oxides (mainly NO and NO<sub>2</sub>), or NO<sub>x</sub>, is the generic term for a group of highly reactive gases, which contain nitrogen and oxygen in various amounts and chemical configurations. Most of the nitrogen oxides are colorless and odorless. However, one very common pollutant, nitrogen dioxide (NO<sub>2</sub>) along with other particles in the air can often be seen as a reddish-brown layer of smog over many cities or heavily populated areas.

## How is NO<sub>x</sub> Created?

Nitrogen oxides form when fuels are burned at high temperatures, as in a combustion process. The primary sources of NO<sub>x</sub> are motor vehicles, electric utilities, and other industrial, commercial, and residential sources like home boilers that burn fuels.

## Causes for Concern about NO<sub>x</sub>

When NO<sub>x</sub> reacts with the oxygen in the air, the result is ground-level ozone. Ground-level ozone has very negative effects on the respiratory system, such as causing lung cancer, and on agricultural production. NO<sub>x</sub> also reacts to form nitrate particles, and acid aerosols, which all cause respiratory problems. Nitric acid, formed when NO<sub>x</sub> reacts with water, can cause acid rain and the deterioration of the quality of water. Acidic gases along with airborne particles cause visibility impairment and lower air quality.

Man-made sources of NO<sub>x</sub>

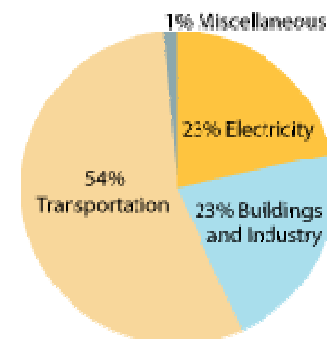

## Types of NO<sub>x</sub>

There are generally three primary sources of NO<sub>x</sub>: thermal NO<sub>x</sub>, fuel NO<sub>x</sub>, and prompt NO<sub>x</sub>. Although all of these are formed through combustion processes, they all differ slightly.

- **Thermal NO<sub>x</sub>** – Thermal NO<sub>x</sub> is formed at very high temperatures, usually above 2200° F, and is a result of the oxidation of the diatomic nitrogen found in combustion air. Thermal NO<sub>x</sub> is the most produced form of NO<sub>x</sub> created during combustion. It is a function of the temperature and the residence time of the nitrogen at that temperature; the higher the temperature of the flame the higher the formation of thermal NO<sub>x</sub>.

- **Fuel NOx** – Fuel NOx is formed when the nitrogen in fuels combines with the excess oxygen in the air. Fuel NOx is a major problem in the burning of oil and coal as it can make up as much as 50% of total emissions when combusting oil and as much as 80% of total emissions when combusting coal.

- **Prompt NOx** – Prompt NOx is formed in the earliest stage of combustion. Prompt NOx is made by the reaction of atmospheric nitrogen with radicals in the air. The levels of prompt NOx are generally very low, so it is usually only of interest for the most exacting emission targets.

**NOx Reduction** – NOx reduction is important in lowering the levels of NOx being released into the atmosphere during combustion. When a form of NOx reduction is used, it is important to have accurate measurements of not only NO but also NO<sub>2</sub> because the ratio of NO to NO<sub>2</sub> is changed. The traditional NO<sub>2</sub> amounts as a percent of total NOx (10% or 1.1 factor) cannot be used when NOx reducing methods are used since it will lead to very significant errors in the calculations. When NOx reduction methods are used, the values for NO<sub>2</sub> can be greater than 50% of the total NOx. It is important to measure **True NOx** (NO + NO<sub>2</sub>) when using NOx reducing methods to maintain the integrity of the measurements.

## NOx Reduction Methods

- **Staged Combustion** – In this NOx reducing method, only a portion of the fuel is burned in the main chamber. All of the fuel is eventually burned, producing the same amount of energy, but this method greatly reduces the temperature in the main chamber. As temperatures decreased, the amount of thermal NOx is reduced.

- **Catalytic Converters** – These devices are utilized to lower the toxicity of the emissions of many combustion processes such as stationary engines, boilers, heaters and internal combustion engines. Catalytic converters break down nitrogen oxides into separate nitrogen and oxygen particles. Some catalytic converters are also used to reduce the high CO levels produced when reducing NOx, as low CO levels are important to ensuring complete combustion.

**CO AND NOx EMISSIONS**  
Worldwide

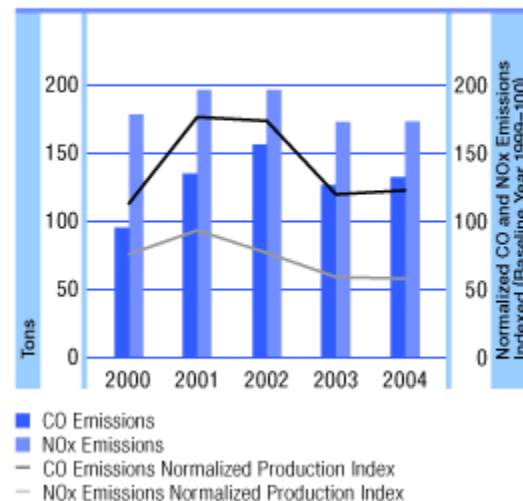

**- Flue Gas Recirculation** – Flue Gas Recirculation, FGR, is a method of NO<sub>x</sub> reduction that lowers the temperature of the flame, and therefore reduces thermal NO<sub>x</sub>. A portion of the exhaust gas is re-circulated into the combustion process, cooling the area. This process may be either external or induced, depending on the method used to move the exhaust gas. Flue Gas Recirculation may also minimize CO levels while reducing NO<sub>x</sub> levels.

**- Reducing O<sub>2</sub> levels** – By reducing the amount of O<sub>2</sub> that is available to react with the nitrogen, NO<sub>x</sub> is reduced. This is achieved through the use of oxygen trim controls. To minimize the O<sub>2</sub> levels, a combustion analyzer is used to adjust the fuel and air mixture. This method can reduce the level of NO<sub>x</sub> produced by up to 10%, but it may increase the emissions of Carbon Monoxide (CO) very significantly. This method is widely used in many processes such as in rich burn engines.

**- Low NO<sub>x</sub> Burners** – By changing the shape and formation of the flame by using plates to control airflow, a more elongated flame is created in the burner. The temperature is decreased due to the extended flame and surface area, and the lower temperature reduces the amount of thermal NO<sub>x</sub>. CO levels may be elevated when using low NO<sub>x</sub> burners. It is important to monitor CO and **True NO<sub>x</sub>** levels to better control Low NO<sub>x</sub> burners.

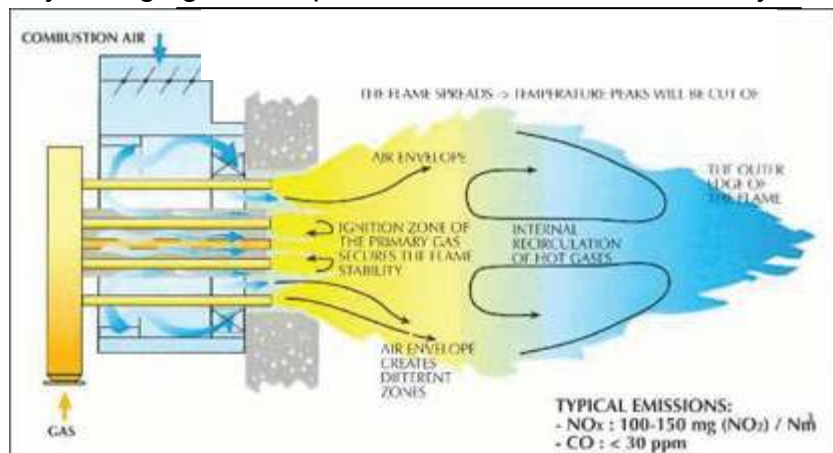

**- Low Nitrogen Fuel Oil** – The use of low nitrogen oils, which can contain up to 15-20 times less fuel bound nitrogen than standard No. 2 oil, can greatly reduce NO<sub>x</sub> emissions as fuel bound nitrogen can contribute anywhere between 20-50% of total NO<sub>x</sub> levels.

**- Water/Steam Injection** – Water or steam injection reduces the amount of NO<sub>x</sub> produced by lowering the temperature of the flame during combustion. The lower temperature allows for the decrease of thermal NO<sub>x</sub>. This method can result in an increase of 3-10% boiler efficiency losses and excess amounts of condensation may form. Some advanced designs of steam injection technology do not have significant impact on boiler efficiency.

- **SCR (Selective Catalytic Reduction)** – SCR is a process where a reductant, most often ammonia, is added to the flue. The reductant then reacts with the NO<sub>x</sub> in the emissions and forms H<sub>2</sub>O and N<sub>2</sub> (ambient nitrogen). This process may take place at anywhere between 500°F and 1200°F depending on the catalyst used. SCR may reduce NO<sub>x</sub> emissions by up to 90%. SCRs are mainly used in large industrial and utility boilers.

- **SNCR (Selective non-catalytic Reduction)** – SNCR is a process that involves a reductant, usually urea, being added to the top of the furnace and going through a very long reaction at approximately 1400-1600 °F. This method is more difficult to apply to boilers due to the specific temperature needs, but it can reduce NO<sub>x</sub> emissions by 70%.

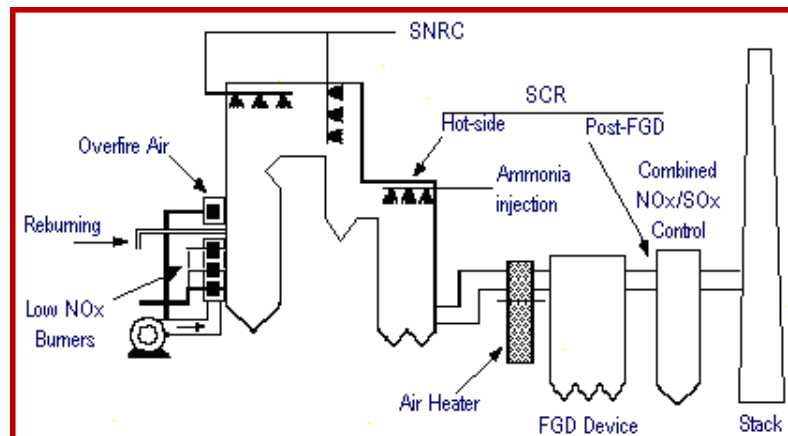

**Measuring NO<sub>x</sub>** – The traditional way to find the value of NO<sub>x</sub> is to take a sample of the gases exiting the stack and measure the level of NO. It is then necessary to multiply this value by 1.1 to account for the additional NO<sub>2</sub>, as NO<sub>x</sub> is the amount of NO added to the amount of NO<sub>2</sub>. This method of measurement is acceptable depending upon the process for EPA reporting, but it is not the most accurate way to measure the quantity as the ratio of NO to NO<sub>2</sub> may vary. Measuring both NO and NO<sub>2</sub> (True NO<sub>x</sub>) is a much more accurate way to determine NO<sub>x</sub> than measuring NO only.

**O<sub>2</sub> Reference** – The O<sub>2</sub> reference is a standard that has been set to help monitor NO<sub>x</sub> emissions. This standard calculates NO<sub>x</sub> emissions based on a set oxygen level, to standardize the monitoring and reporting of total amounts of NO<sub>x</sub> emitted. The O<sub>2</sub> reference is effective in removing any attempts of diluting emissions, which can make NO<sub>x</sub> levels appear lower than they actually are.



**Low NOx** – Low NOx is typically defined as any value of NOx that is under 500 ppm. The most common values are between 9 and 300 ppm. It is most imperative to measure **True NOx** (NO+NO<sub>2</sub>) when dealing with these low values to reduce the error since a few ppm error accounts for a significant amount of the Total NOx.

**True NOx** – True NOx is a method of measuring the value of NOx emissions without using any factors or presumptions. The concentrations of NO and NO<sub>2</sub> are measured separately with high accuracy sensors and the values are then added together to find the True “Total” NOx value. It is especially important to measure True NOx when dealing with low NOx emissions to reduce error.

## True NOx vs. NOx

$$\text{NO} + \text{NO}_2 \text{ (Measured)} = \text{NOx} \quad \text{NO} + \text{NO}_2 \text{ (Calculated)} = \text{NOx}$$

**Measuring True NOx** – There are specific instruments that quantify the level of NO and NO<sub>2</sub> in a sample. Before being able to measure NOx, it is important to locate a sample that is representative of the emissions being released into the atmosphere. Therefore, it is important to take the sample from the right location and to be sure that there are no gas leaks.

**Problems With Measuring NO<sub>2</sub>** – It is very important that when taking NO<sub>2</sub> measurements all precautions are taken to ensure that the integrity of the data is kept. This can be achieved by making sure that condensation does not build up, as NO<sub>2</sub> is very water-soluble. If there is condensation, as much as 50% of the NO<sub>2</sub> can dissolve out of the gas phase into the condensate, affecting the readings greatly.

## Best Method for Measuring NO<sub>2</sub>

Given the solubility of the NO<sub>2</sub> gas, it is imperative that the integrity of the gas sample is maintained and all the water is eliminated under a controlled environment minimizing any contact with the sample gas; this can be achieved by using a sampling system that includes the following components:



- **Heated Probe**
- **Heated Sample Line**
- **Chiller**

- **Heated Probe** – A heated probe allows for flue gas sampling without condensation, which maximizes the accuracy of the measurement. With the heated probe, the combustion gases cannot dissolve into the condensate. Therefore, the sample remains representative of the emissions in the stack.

- **Heated Sample Line** – A heated sample line is used to keep the gas sample above to dew point to prevent the absorption of gases into the water phase. This provides conditions for more accurate measurements as gases are not lost into the condensate.

- **Chiller** - An internal chiller dries the flue gas to avoid dilution of NO<sub>2</sub> and SO<sub>2</sub> into the condensate. This allows for a sample that is most representative of the emissions being released, as none of the gases are lost into the water phase.

**Carbon Monoxide** – Carbon monoxide, CO, is a highly toxic gas that can form during incomplete combustion. CO is colorless, odorless, and extremely harmful to the respiratory system. Overexposure to carbon monoxide can cause headache, dizziness, and sometimes death. It is of the greatest importance to measure CO emissions to maintain safety. During combustion most of the carbon burned reacts to form carbon dioxide, however some of the carbon stays in the intermediary stage as carbon monoxide. Excess levels of CO can be created due to incomplete combustion, poor burner design, bad firing conditions, or a leaky furnace. Motor vehicles, industries, and incomplete combustion are the primary producers of manmade CO.

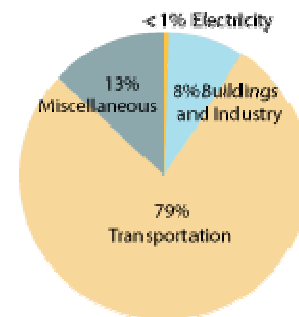

**Man-made Sources of CO**

**Gas Turbines**  
Influence of temperature on CO and NOx emissions

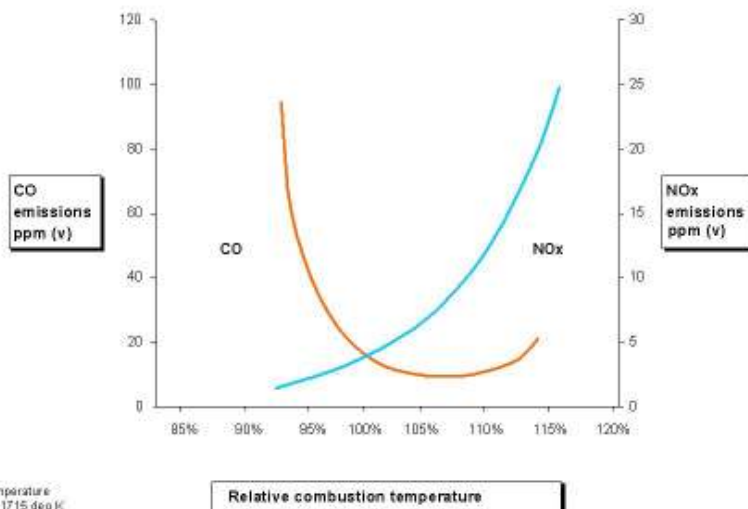

As discussed earlier, some of the NOx reduction methods used in boilers bring with them an increase of CO emissions that may be regulated by the federal, state, and/or local environmental regulatory agencies.

This graph shows a traditional correlation between the NOx and CO emissions at different relative combustion temperatures.

NOTES  
1) 100% Temperature is approx 1715 deg K

# Emissions of Sulfur Compounds

**Sulfur Dioxide** – Sulfur dioxide,  $\text{SO}_2$ , makes up about 95% of all of the sulfur oxides that is released during combustion.

$\text{SO}_2$  is a main cause of acid rain when it reacts with water vapor. The EPA regulates the emissions of sulfur dioxide through its Acid Rain Program. Most sulfur dioxide is produced through the production of electricity and through industrial processes.

**Sources of Sulfur Dioxide**

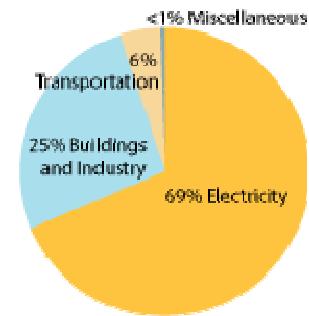

**Sulfur Trioxide** – Sulfur trioxide,  $\text{SO}_3$ , is not abundant in combustion but is problematic as it is a source of corrosion in the cold areas of boilers. In most processes, measuring  $\text{SO}_3$  emissions is not required, but  $\text{SO}_3$  should be eliminated to avoid deterioration of parts.

**Hydrogen Sulfide** – Hydrogen Sulfide,  $\text{H}_2\text{S}$ , is a colorless, flammable, and toxic gas that can form in combustion. Certain gases, such as natural gas, can contain up to 28% of  $\text{H}_2\text{S}$ .  $\text{H}_2\text{S}$  can be formed through many processes such as hydrodesulphurization.

## Sulfur Oxide Reduction

- **Low Sulfur Fuel** – Low sulfur fuel reduces the initial amount of sulfur in the system, therefore lowering the amount of  $\text{SO}_2$  being released into the atmosphere.

- **Fuel Desulfurization** – Fuel desulfurization involves removing some of the sulfur from the fuel before it is burned. Fuel desulfurization is mainly used when coal is the fuel being utilized.

- **Flue Gas Desulfurization Systems** – Flue gas desulfurization, FGD, involves the use of scrubbers that chemically react with the  $\text{SO}_2$  to form other compounds. There are two methods, regenerable FGD and non-regenerable FGD that vary in how much and what kind of waste is produced. This method is very effective and can reduce sulfur oxide emissions by up to 90%.

**Best Method to Measuring  $\text{SO}_2$**  - Given the solubility of the  $\text{SO}_2$  gas, it is imperative that the integrity of the gas sample is maintained and all the water is eliminated under a controlled environment minimizing any contact with the sample gas; this can be achieved by using a similar sampling system as the one discussed to measuring  $\text{NO}_2$ , which should include a *Heated Probe, Heated Sample Line, and Chiller*.

## Carbon Dioxide

Carbon Dioxide, CO<sub>2</sub>, is always a byproduct of combustion. The level of carbon dioxide released is dependent upon the type of fuel used and the combustion process. Although naturally produced through respiration and other organic processes, carbon dioxide is a green house gas and thus advances global warming. The primary sources of manmade carbon dioxide are motor vehicles, industries, and electric utilities.

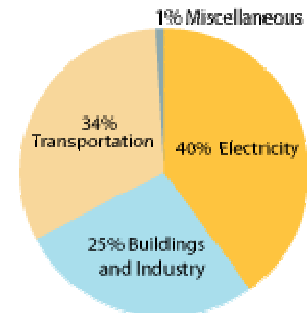

Man-made Sources of CO<sub>2</sub>

### Calculating vs. Measuring CO<sub>2</sub>

Calculating CO<sub>2</sub> (Actual) is a function of the stoichiometric maximum amount of CO<sub>2</sub> (Maximum) that can be released by a given fuel and the O<sub>2</sub> concentration, as shown in the following equation:

$$\% \text{ CO}_2 \text{ (Actual)} = \text{CO}_2 \text{ (maximum)} \times \frac{(20.9 - \% \text{O}_2 \text{ measured})}{20.9}$$

Most combustion processes use fuels, or a combination of different fuels, that have variable amounts of carbon, making the calculation of the CO<sub>2</sub> max extremely difficult. With the CO<sub>2</sub> max constantly changing, it is impossible to accurately calculate CO<sub>2</sub> based on the oxygen levels in the flue gases. In those situations, monitoring the CO<sub>2</sub> levels is imperative.

Measuring CO<sub>2</sub> is normally achieved by using non-dispersive infrared (NDIR) technology.

### Mass Emissions and Gas Velocity

Mass emissions are a calculation of the total amounts of gases being released during the combustion process. Instead of finding concentrations of gases in ppm (parts per million volume), mass emissions indicate the total amount of emissions being released in units such as LB/H (pounds per hour) or tons per year. Mass emissions can be found by knowing the concentration of the gases being released, the amount of fuel that is burned, and the mass of the fuel. To know the mass of the fuel however, it is necessary to know the exact chemical formula for the fuel. Another way to calculate mass emissions is based on the velocity of the gases being sent out of the stack, the cross sectional area of the stack, and the concentration of the gases being sent out of the stack.

## What is Combustion Analysis?

During combustion analysis, the quantities and concentrations of gases are measured precisely in order to maintain the safest and most efficient conditions possible. The first step in combustion analysis is the measurement of gas temperature, flue gas concentrations, as well as draft pressures and soot levels. These measurements are made by inserting a probe into the exhaust flue and taking a sample. A carefully positioned thermocouple measures the highest exhaust gas temperature. The draft pressure is calculated by finding the difference in pressure between the inside and the outside of the exhaust flue. The concentrations of the undesired combustion gases can be measured using different kinds of methods such as the electrochemical and non-dispersive infrared sensors.

## O<sub>2</sub> and CO<sub>2</sub> Depending on Excess Air

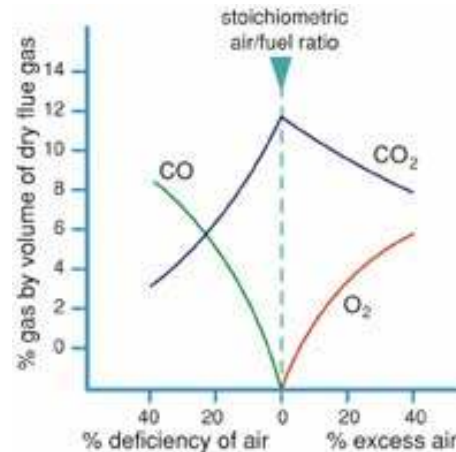
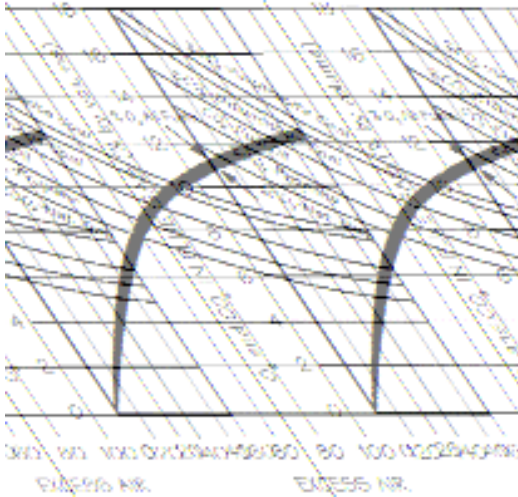

**Gas Analyzers-** Gas Analyzers are the ideal tool to monitor gas emissions and therefore maintain the best Total Efficiency, which, as we discussed, is a balance between the combustion efficiency, environmental efficiency, and a safe working environment. In addition, Combustion Analyzers/Gas Analyzers can help identify maintenance problems as the boilers deteriorate with time.

Many gas analyzers measure and calculate a wide array of parameters including:

<b>Combustion Efficiency</b>	<b>Oxygen</b>	<b>CO<sub>2</sub></b>	<b>Flue Gas Temperature</b>
<b>Ambient Temperature</b>	<b>Draft</b>	<b>CO</b>	<b>Excess Air</b>
<b>True NO<sub>x</sub> (NO+NO<sub>2</sub>)</b>	<b>SO<sub>2</sub></b>	<b>H<sub>2</sub>S</b>	<b>Hydrocarbons (C<sub>x</sub>H<sub>y</sub>)</b>
	<b>Gas Velocity</b>	<b>Mass Emissions</b>	

Analyzers with greater resolution and accuracy help to meet the standards set by the EPA.



## Using Gas Analyzers

**How to Take Gas Samples-** The first step in taking a gas sample is to make a small hole in the flue pipe that is sized to fit the probe closely, so air leaks are minimized. To get the most accurate measurement, the gas-sampling probe must be placed prior to any draft damper or diverter, so that the gases are not diluted, and as close to the equipment breach as possible so the gases have not cooled in the flue. If there is a stack economizer or similar device, the measurement should be taken just downstream of the installed device. It is important to note that in order to have the most accurate, representative measurements, there should be no gas leaks.

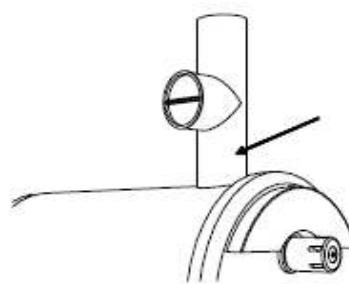

## Making Temperature Measurements-

In order to make temperature measurements, the thermocouple probe is placed at the point of highest exhaust gas temperature at the base of the flue and toward the center for small ducts. If the stack gas temperature is underestimated, the operating efficiency will be overstated.

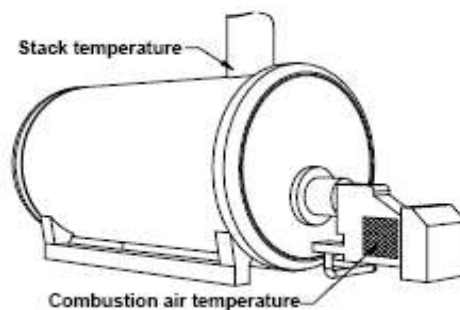
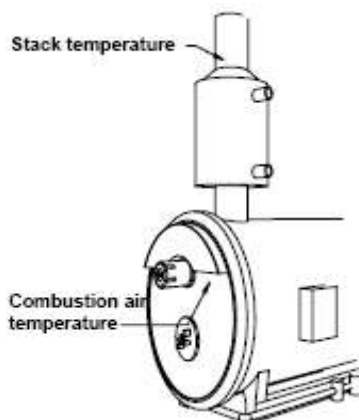

**Taking O<sub>2</sub> Measurements** - After calibrating the instrument used to measure O<sub>2</sub> levels, it is necessary to put the analyzer where the emissions are released, usually the stack. Start the combustion process and look for stability in the oxygen readings for anywhere between one to three minutes.

## Soot/Smoke/Particulate Measurements-

Soot is most commonly measured during equipment tune-up and maintenance by extracting a sample of the exhaust gases using a manual sampling pump or a special soot probe. The sample is taken from the same location as the stack temperature measurements. These measurements may be made with smoke pumps or with probes that have filters.



**Keeping Records-** Documenting your measurements is fundamental to insure short and long term understanding of your combustion process. As the boiler changes with time, it is important to compare today's measurements to past data to identify components in the combustion system that justify replacing to maximize the combustion efficiency of the process.



Gas analyzers with built-in printers and/or data logging capabilities provide for the best methods of data storing and record keeping.

**Summary-** Every combustion process has its own independent identity and behavior. Extrapolating results from one boiler to another will not provide for the best operating results. For that reason, it is important to measure the many parameters discussed in this paper, in order to set and operate the combustion process at the point where the best balance between the Combustion Efficiency, Maintenance Efficiency, Safety, and Environmental Efficiency is reached. At that point, you will have a boiler operating at its best Total Efficiency.

